

750-611

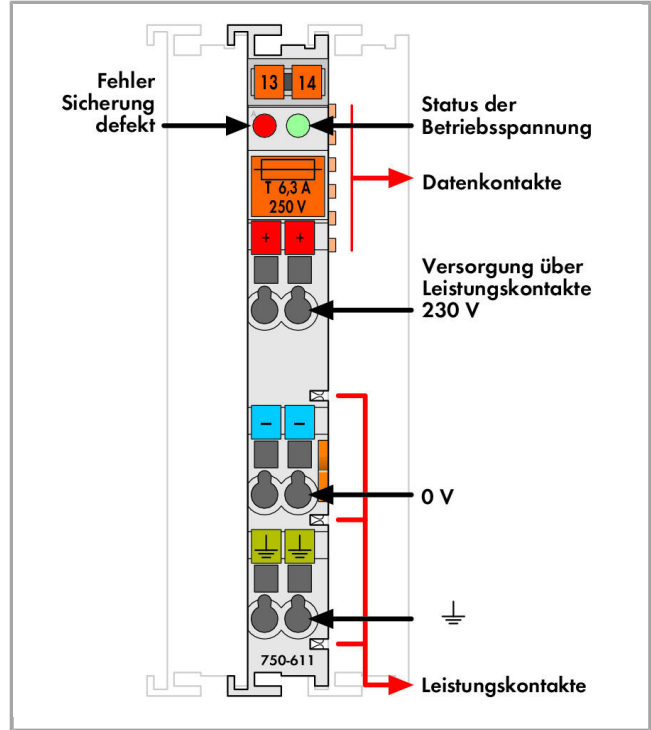

RoHS Compliant

[BOMcheck.net](https://www.bomcheck.net)

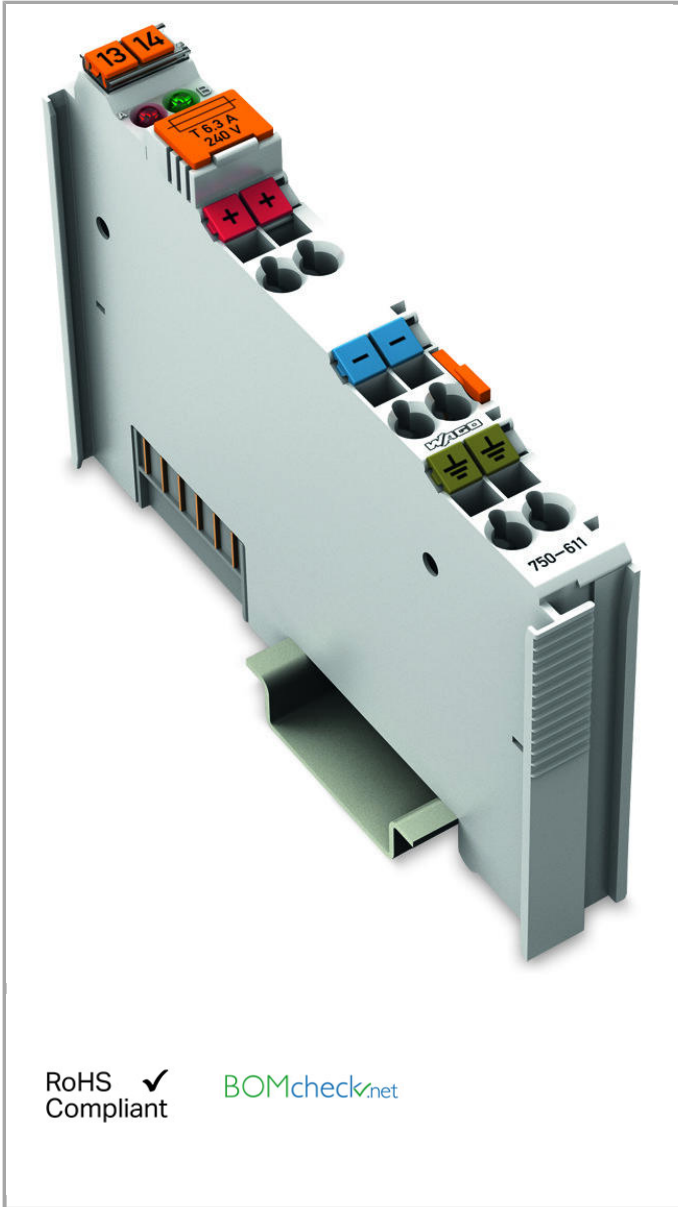
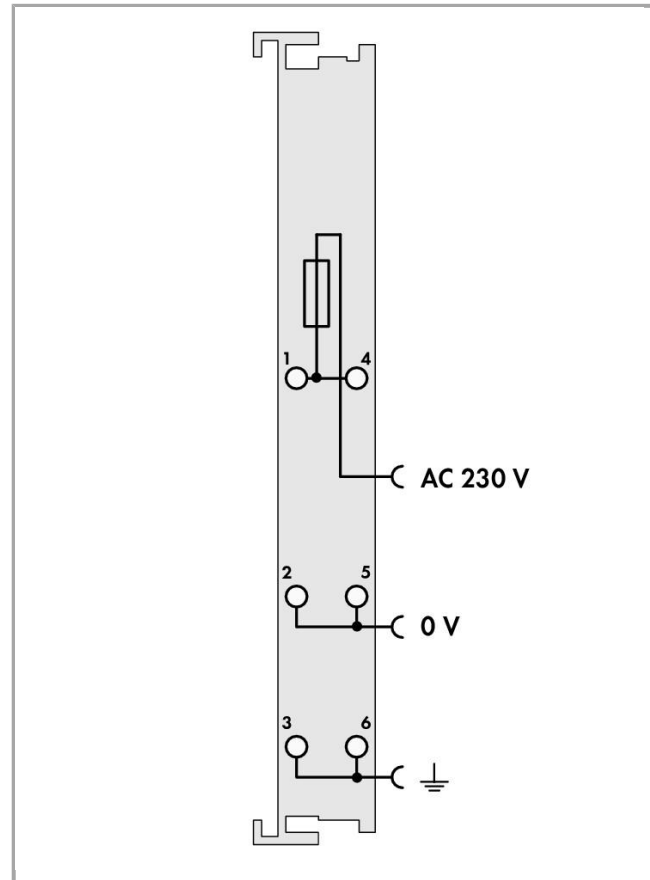
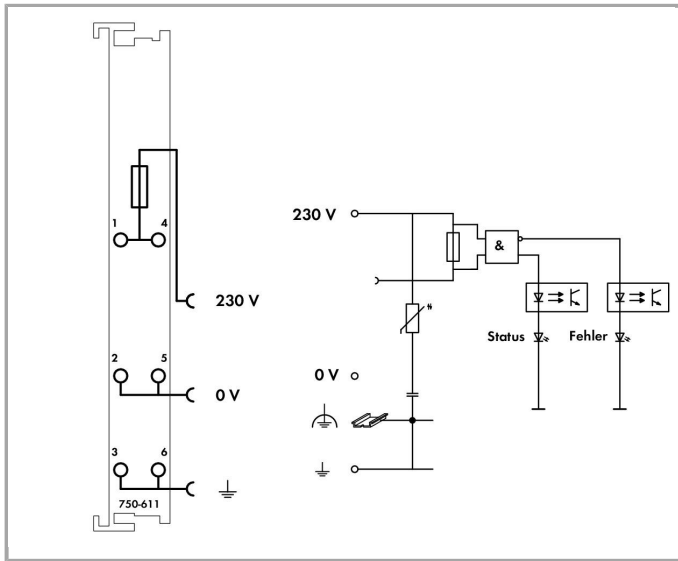

Item description

The supply module provides the I/O modules with the corresponding supply potential.

The maximum current at the supply module is 6.3A. When configuring the system, it must be ensured that this total current is not exceeded. Should higher currents be necessary, intermediate supply modules must be added in the assembly.

This module is fuse-protected (5 x 20mm). The fuse can be changed quickly, with ease, from the retractable fuse carrier.

A blown fuse and the status of the supply voltage are indicated via LEDs.

The I/O module sends information about the status of the supply module to the fieldbus coupler through two input bits. One bit is for the status of the fuse. The other bit is for the status of the supply voltage.

Data

Technical Data

Type of signal	Voltage
Diagnostics	Supply voltage (field): detection "on" at > 164 VAC; detection "off" at < 40 VAC
Fuse	5 x 20; T 6.3 A (not included)
Bit width	2 Bit (1 Bit Spannungsüberwachung, 1 Bit Sicherung defekt)
System supply voltage	DC 5 V; via data contacts

Current consumption, system supply (5 V)	5 mA
System and sensor supply voltage)
Field supply voltage	AC 230 V (-15 ... +10 %); via wiring level (CAGE CLAMP® connection)
Number of outgoing power jumper contacts	3
Current carrying capacity of the power jumper contacts	6.3 A

Connection data

Connection technology: field supply	6 x CAGE CLAMP®
Connection type (1)	Field supply
Solid conductor	0.08 ... 2.5 mm ² / 28 ... 14 AWG
Fine-stranded conductor	0.08 ... 2.5 mm ² / 28 ... 14 AWG
Strip length	8 ... 9 mm / 0.31 ... 0.35 inch

Geometrical Data

Width	12 mm / 0.472 inch
Height	69.8 mm / 2.748 inch
Height from upper-edge of DIN-35 rail	62.6 mm / 2.465 inch
Depth	100 mm / 3.937 inch

Mechanical data

Type of mounting	DIN-35 rail
------------------	-------------

Material Data

Color	light gray
Housing material	Polycarbonate, polyamide 6.6
Fire load	1.488 MJ
Weight	51 g
Conformity marking	1

Environmental Requirements

Surrounding air (operating) temperature	0 ... 55 °C
Surrounding air (storage) temperature	-40 ... 85 °C
Protection class	IP20
Degree of pollution (5)	2 per IEC 61131-2
Operating altitude	0 ... 2000 m
Mounting position	horizontal (standing/lying) or vertical
Relative air humidity (no condensation)	95 %
Vibration resistance	4g per IEC 60068-2-6
Shock resistance	15g per IEC 60068-2-27



EMC immunity to interference	acc. to EN 61000-6-2, marine applications
EMC emission of interference	acc. to EN 61000-6-4, marine applications
Exposure to pollutants	Per IEC 60068-2-42 and IEC 60068-2-43
Permissible H ₂ S contaminant concentration at a relative humidity 75 %	10 ppm
Permissible SO ₂ contaminant concentration at a relative humidity 75 %	25 ppm

Commercial data

Product Group	15 (Remote I/O)
Country of origin	DE
GTIN	4045454535186
Customs Tariff No.	85389091890

Approvals / Certificates

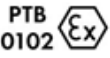
Ex-Approvals

Logo	Approval	Additional Approval Text	Certificate name
	ATEX TUEV Nord Cert GmbH	EN 60079-0	TÜV 07 ATEX 554086 X en.
	TUEV Nord TUEV Nord Cert GmbH	IEC 60079-0	IECEX TUN 09.0001 X
	UL Underwriters Laboratories Inc. (HAZARDOUS LOCATIONS)	ANSI/ISA 12.12.01	E198726 Sec.1

Country specific Approvals

Logo	Approval	Additional Approval Text	Certificate name
	KC National Radio Research Agency	Article 58-2, Clause 3	MSIP- REM-W43- SPP750

Ship Approvals

Logo	Approval	Additional Approval Text	Certificate name
	ABS American Bureau of Shipping	-	19- HG1821926



BV
Bureau Veritas S.A.

-

13453/DO BV



DNV GL
Det Norske Veritas, Germanischer Lloyd

-

TAA0000194



LR
Lloyds Register

-

02/20026 (E5)



NK
Nippon Kaiji Kyokai

-

TA17255M



PRS
Polski Rejestr Statków

-

TE/2236
/880590/19



PRS
Polski Rejestr Statków

-

TE/1989
/880590/13



RINA
RINA Germany GmbH

-



















ELE134212XG











UL-Approvals

Logo	Approval	Additional Approval Text	Certificate name
	UL UL International Netherlands B.V. (ORDINARY LOCATIONS)	UL 508	E175199 Sec.1





Compatible products

















Carrier rail







	Item no.: 210-112 Steel carrier rail; 35 x 7.5 mm; 1 mm thick; 2 m long; slotted; according to EN 60715; "Hole width 25 mm	210-112
	Item no.: 210-113 Steel carrier rail; 35 x 7.5 mm; 1 mm thick; 2 m long; unslotted; according to EN 60715	210-113
	Item no.: 210-114 Steel carrier rail; 35 x 15 mm; 1.5 mm thick; 2 m long; unslotted; similar to EN 60715	210-114
	Item no.: 210-115 Steel carrier rail; 35 x 7.5 mm; 1 mm thick; 2 m long; slotted; according to EN 60715; "Hole width 18 mm	210-115
	Item no.: 210-118 Steel carrier rail; 35 x 15 mm; 2.3 mm thick; 2 m long; unslotted; according to EN 60715	210-118
	Item no.: 210-196 Aluminum carrier rail; 35 x 8.2 mm; 1.6 mm thick; 2 m long; unslotted; similar to EN 60715	210-196
	Item no.: 210-197 Steel carrier rail; 35 x 15 mm; 1.5 mm thick; 2 m long; slotted; similar to EN 60715	210-197
	Item no.: 210-198 Copper carrier rail; 35 x 15 mm; 2.3 mm thick; 2 m long; unslotted; according to EN 60715	210-198
	Item no.: 210-504 Steel carrier rail; 35 x 7.5 mm; 1 mm thick; 2 m long; slotted; galvanized; according to EN 60715	210-504
	Item no.: 210-505 Steel carrier rail; 35 x 7.5 mm; 1 mm thick; 2 m long; unslotted; galvanized; according to EN 60715	210-505
	Item no.: 210-506 Steel carrier rail; 35 x 15 mm; 1.5 mm thick; 2 m long; unslotted; galvanized; similar to EN 60715	210-506
	Item no.: 210-508 Steel carrier rail; 35 x 15 mm; 1.5 mm thick; 2 m long; slotted; galvanized; similar to EN 60715	210-508
system box		
	Item no.: 850-804 IP65 enclosure; Stainless steel; WxHxD (400x123x200 mm); 4 x M20, 16 x M16, 28 x M12 cable grip	850-804
	Item no.: 850-804/000-001 IP65 enclosure; Stainless steel; WxHxD (400x123x200 mm); 2 x M20, 13 x M16, 32 x M12 cable grip	850-804
	Item no.: 850-805 IP65 enclosure; Stainless steel; WxHxD (600x123x200 mm); 4 x M20, 19 x M16, 67 x M12 cable grip	850-805
	Item no.: 850-814/002-000 IP65 enclosure; Sheet steel (RAL 7035); WxHxD (200x120x200 mm); without flange plate	850-814
	Item no.: 850-815/002-000 IP65 enclosure; Sheet steel (RAL 7035); WxHxD (300x120x200 mm); without flange plate	850-815
	Item no.: 850-816/002-000 IP65 enclosure; Sheet steel (RAL 7035); WxHxD (400x120x200 mm); without flange plate	850-816

	Item no.: 850-817/002-000 IP65 enclosure; Sheet steel (RAL 7035); WxHxD (600x120x200 mm); without flange plate	850-817 /002-000
	Item no.: 850-825 IP65 enclosure; Aluminium (RAL 7032); WxHxD (160x100x160 mm); 9 x M12, 4 x M20	850-825
	Item no.: 850-826 IP65 enclosure; Aluminium (RAL 7032); WxHxD (240x100x160 mm); 4 x M20, 4 x M16, 14 x M12 cable grip	850-826
	Item no.: 850-826/002-000 IP65 enclosure; Aluminium (RAL 7035); WxHxD (240x100x160 mm); 4 x M20, 4 x M16, 14 x M12 cable grip	850-826 /002-000
	Item no.: 850-827 IP65 enclosure; Aluminium (RAL 7032); WxHxD (320x100x160 mm); 4 x M20, 8 x M16, 17 x M12 cable grip	850-827
	Item no.: 850-827/002-000 IP65 enclosure; Aluminium (RAL 7035); WxHxD (320x100x160 mm); 4 x M20, 8 x M16, 17 x M12 cable grip	850-827 /002-000
	Item no.: 850-828 IP65 enclosure; Aluminium (RAL 7032); WxHxD (480x100x160 mm); 4 x M20, 10 x M16, 35 x M12 cable grip	850-828
	Item no.: 850-828/002-000 IP65 enclosure; Aluminium (RAL 7035); WxHxD (480x100x160 mm); 4 x M20, 10 x M16, 35 x M12 cable grip	850-828 /002-000
	Item no.: 850-834 IP65 enclosure; Polyester (RAL 7032); WxHxD (164x100x164 mm); 9 x M12, 4 x M20	850-834
	Item no.: 850-835 IP65 enclosure; Polyester (RAL 7032); WxHxD (244x100x164 mm); 4 x M20, 4 x M16, 14 x M12 cable grip	850-835
	Item no.: 850-836 IP65 enclosure; Polyester (RAL 7032); WxHxD (324x100x164 mm); 4 x M20, 8 x M16, 17 x M12 cable grip	850-836

Marking accessories

	Item no.: 2009-145 Mini-WSB Inline; for Smart Printer; on reel; stretchable 5 - 5.2 mm; plain; snap-on type	2009-145
	Item no.: 2009-145/000-002 Mini-WSB Inline; for Smart Printer; on reel; stretchable 5 - 5.2 mm; plain; snap-on type	2009-145 /000-002
	Item no.: 2009-145/000-005 Mini-WSB Inline; for Smart Printer; on reel; stretchable 5 - 5.2 mm; plain; snap-on type	2009-145 /000-005
	Item no.: 2009-145/000-006 Mini-WSB Inline; for Smart Printer; on reel; stretchable 5 - 5.2 mm; plain; snap-on type	2009-145 /000-006
	Item no.: 2009-145/000-007 Mini-WSB Inline; for Smart Printer; on reel; stretchable 5 - 5.2 mm; plain; snap-on type	2009-145 /000-007

	Item no.: 2009-145/000-012 Mini-WSB Inline; for Smart Printer; on reel; stretchable 5 - 5.2 mm; plain; snap-on type	7000-012	2009-145
	Item no.: 2009-145/000-023 Mini-WSB Inline; for smartPRINTER; on reel; stretchable 5 - 5.2 mm; plain; snap-on type	7000-023	2009-145
	Item no.: 2009-145/000-024 Mini-WSB Inline; for Smart Printer; on reel; stretchable 5 - 5.2 mm; plain; snap-on type	7000-024	2009-145
	Item no.: 248-501 Miniature WSB Quick marking system; plain; Marker width 5 mm; 10 strips with 10 markers per card		248-501
	Item no.: 248-501/000-002 Mini-WSB marking card; as card; not stretchable; plain; snap-on type	7000-002	248-501
	Item no.: 248-501/000-005 Mini-WSB marking card; as card; not stretchable; plain; snap-on type	7000-005	248-501
	Item no.: 248-501/000-006 Mini-WSB marking card; as card; not stretchable; plain; snap-on type	7000-006	248-501
	Item no.: 248-501/000-007 Mini-WSB marking card; as card; not stretchable; plain; snap-on type	7000-007	248-501
	Item no.: 248-501/000-012 Mini-WSB marking card; as card; not stretchable; plain; snap-on type	7000-012	248-501
	Item no.: 248-501/000-017 Mini-WSB marking card; as card; not stretchable; plain; snap-on type	7000-017	248-501
	Item no.: 248-501/000-023 Mini-WSB marking card; as card; not stretchable; plain; snap-on type	7000-023	248-501
	Item no.: 248-501/000-024 Mini-WSB marking card; as card; not stretchable; plain; snap-on type	7000-024	248-501
	Item no.: 750-100 Marker card; as a DIN A4 sheet; plain		750-100
	Item no.: 750-103 Group marker carrier		750-103
	Item no.: 750-106 Group marker carrier		750-106
shield connection			
	Item no.: 790-108 Shield clamping saddle; 11 mm wide; diameter of compatible conductor		790-108

	Item no.: 790-116 Shield clamping saddle; 19 mm wide; diameter of compatible conductor; 7 ... 16 mm	790-116
	Item no.: 790-124 Shield clamping saddle; 27 mm wide; diameter of compatible conductor; 6 ... 24 mm	790-124
	Item no.: 790-140 Shield clamping saddle; diameter of compatible conductor	790-140
	Item no.: 790-208 Shield clamping saddle; 12.4 mm wide; 3 ... 8 mm	790-208
	Item no.: 790-216 Shield clamping saddle; 21.8 mm wide; 6 ... 16 mm	790-216
	Item no.: 790-220 Shield clamping saddle; 30 mm wide; 6 ... 20 mm	790-220

Downloads

Documentation

Manual

230VAC, max. 6.3A without diagnostics, with fuse holder	V 1.0.2	pdf 264.7 kB	Download
------------------------------------------------------------	---------	-----------------	----------

Bid Text

750-611 IO-Klemmen	Apr 4, 2012	doc 26.6 kB	Download
-----------------------	-------------	----------------	----------

Additional Information

Disposal; Electrical and electronic equipment, Packaging	V 1.0.0	pdf 265.8 kB	Download
----------------------------------------------------------	---------	-----------------	----------

System Description

Use in Hazardous Environments Term definition, marking and installation regulations	V 1.0.0	pdf 1.0 MB	Download
----------------------------------------------------------------------------------------	---------	---------------	----------

Design Notes Basic conditions and recommendations for higher operational safety	V 2.0.0	pdf 1.5 MB	Download
------------------------------------------------------------------------------------	---------	---------------	----------

Overview on WAGO-I/O-SYSTEM 750 approvals		pdf 780.2 kB	Download
-------------------------------------------	--	-----------------	----------

750/753 Series I/O-System – General Product Information		pdf 1.7 MB	Download
---------------------------------------------------------	--	---------------	----------

CAD/CAE - Smart Data



CAD data

3D Download 750-611

URL

Download

Device Files

Device Driver

WAGO USB Service Cable Driver / 750 and 857 Series
759-923

6.5.3.0
Sep 10, 2014

zip
4.8 MB

Download

Product family

750/753 Series I/O-System
[Learn more about the product family.](#)

[Show all products from the family](#)

Subject to changes.
